

MR-257

An Overview of G.993.5 Vectoring

Issue: 2
Issue Date: March 2014

MR Issue History

Issue Number	Approval Date	Publication Date	Issue Editor	Changes
1	May 2012		Peter Silverman, ASSIA	Original
2	March 2014	16 May 2014	Dong Wei, Huawei	See Executive Summary

Comments or questions about this Broadband Forum Marketing Report should be directed to help@broadband-forum.org.

Editor Dong Wei Huawei Technologies

White Paper Chair Tom DiMicelli Juniper Networks

TABLE OF CONTENTS

EXECUTIVE SUMMARY	5
1 WHAT IS VECTORING - A TECHNICAL OVERVIEW	8
1.1 CAPABILITIES – LOOP REACH AND RATE	12
1.1.1 Performance of G.993.5 for the VDSL2 Annex A 17a band profile	12
1.1.2 Performance of G.993.5 for the VDSL2 Annex B 17a and 30a band profile	13
2 STATUS OF THE TECHNOLOGY IN THE MARKET	15
2.1 STANDARDIZATION	15
3 ARCHITECTURE	16
4 ISSUES FOR THE NETWORK OPERATOR AND THE REGULATOR	18
4.1 BINDER MANAGEMENT ISSUES	19
4.2 UNBUNDLED SCENARIOS AND GRADUAL DEPLOYMENT OF VECTORING	20
4.2.1 Physical loop unbundling	20
4.2.2 Service in areas with legacy VDSL	21
4.2.3 Options for mitigating or avoiding the impact of uncanceled crosstalk on vectored lines	21
4.3 ALIEN NOISE	23
4.4 BONDING AND VECTORING	23
4.5 WIRING INSIDE THE CUSTOMER PREMISES	24
4.6 ADDITION AND REMOVAL OF VDSL2 SIGNALS ON OTHER LINES	24
4.7 MEASURING AND MONITORING PERFORMANCE GAIN	24
4.8 DIAGNOSING THE VECTORING FUNCTION	24
4.9 DIAGNOSING THE CABLE CHARACTERISTICS	24
4.10 DIAGNOSING NOISE CHARACTERISTICS	25
4.11 VECTORING MANAGEMENT	25
5 CONCLUSION	26
6 REFERENCES	27
7 DEFINITIONS	28
8 ABBREVIATIONS	31

List of Figures

Figure 1 - Broadband access-connections for Q4 2012 (source: Point Topic). FTTx includes VDSL2, FTTx+LAN, etc.....	6
Figure 2 - Reference Fiber Fed DSL Network Access Architecture	8
Figure 3 - Crosstalk in Access Cable	9
Figure 4 - Downstream FEXT Cancellation Pre-coding in DSLAM	10
Figure 5 - Example band plans for profile 17a	12
Figure 6 - Downstream Rates – Profile 17a, 26 AWG, -136 dBm/Hz noise, 80 users, and 47 cancelled	13
Figure 7 - VDSL2 Annex B Profile 17a downstream loop reach and rate	14
Figure 8 - VDSL2 Annex B Profile 30a downstream loop reach and rate	14
Figure 9 - Schematic of Deployment Architectures	16

List of Tables

Table 1 - Vectoring – Applications and Network Architecture	16
Table 2 – Management Goals and Functions Common to Both Vectored DSL and Other Network Services	18
Table 3 – Management Concerns for Vectoring.....	18

Executive Summary

Current broadband penetration approaches 645 million lines worldwide and continues to grow at a rate of over 12% per year [1]. As is shown in Figure 1, DSL remains the dominant broadband access. VDSL2 (ITU-T G.993.2 [2]) provides a growing proportion of both the DSL component as well as the final leg of the broadband access connection in the “FTTx” solutions listed by Point-Topic in Figure 1. Not only is deployment of broadband increasing rapidly but also the bandwidth and quality of service requirements of the applications demanded by users continues to increase. While relatively recently bandwidths in the range of 5 to 10 Mb/s toward the customer were considered to provide an acceptable premium broadband service, today significantly higher bandwidths are required to support requirements for services such as High Definition IPTV and bandwidth requirements continue to increase as application capabilities evolve. Bandwidths considerably in excess of 30 Mb/s toward the customer premises are necessary to deliver the emerging advanced services.

In 2010, ITU-T published the G.993.5 Recommendation, *Self-FEXT cancellation (vectoring) for use with VDSL2 transceivers* [3], informally known as G.vector, which allows DSL connections to meet these enhanced requirements. VDSL2 deployments based on this new Recommendation facilitate achieving the quality of service required for premium services such as multiple channels of HDTV (MR-180 [4]). Systems based on the G.993.5 Recommendation have the potential of being deployed in the field as an enhancement to existing DSL deployments thus reusing existing capital assets. G.993.5 achieves its improvements by canceling, using a mathematical process known as vectoring, the majority of DSL’s crosstalk noise. Since the DSL lines in a cable no longer interfere with each other the total throughput of each line and the total throughput of all lines in the cable is significantly increased. G.993.5 is capable of supporting connection speeds (downstream) in excess of 100 Mb/s at distances up to 500m (1500 ft) from a fiber fed DSLAM using VDSL2 on typical telephone wiring¹. Even with loops as long as 1200m (4000 ft) rates toward the customer (‘downstream’) that exceed 40 Mb/s over a single copper pair are supported.

With its potential for increased bandwidth using VDSL2 technology, G.993.5 is being considered by a number of carriers to enhance their DSL based network services. This report MR-257 Issue 2 (MR-257) builds on the previous MR-257 Issue 1 [5] providing an introduction to this vectored VDSL2 technology, its applicability and opportunities.

¹ E.g, PE 0.5 mm or 24 AWG twisted pair.

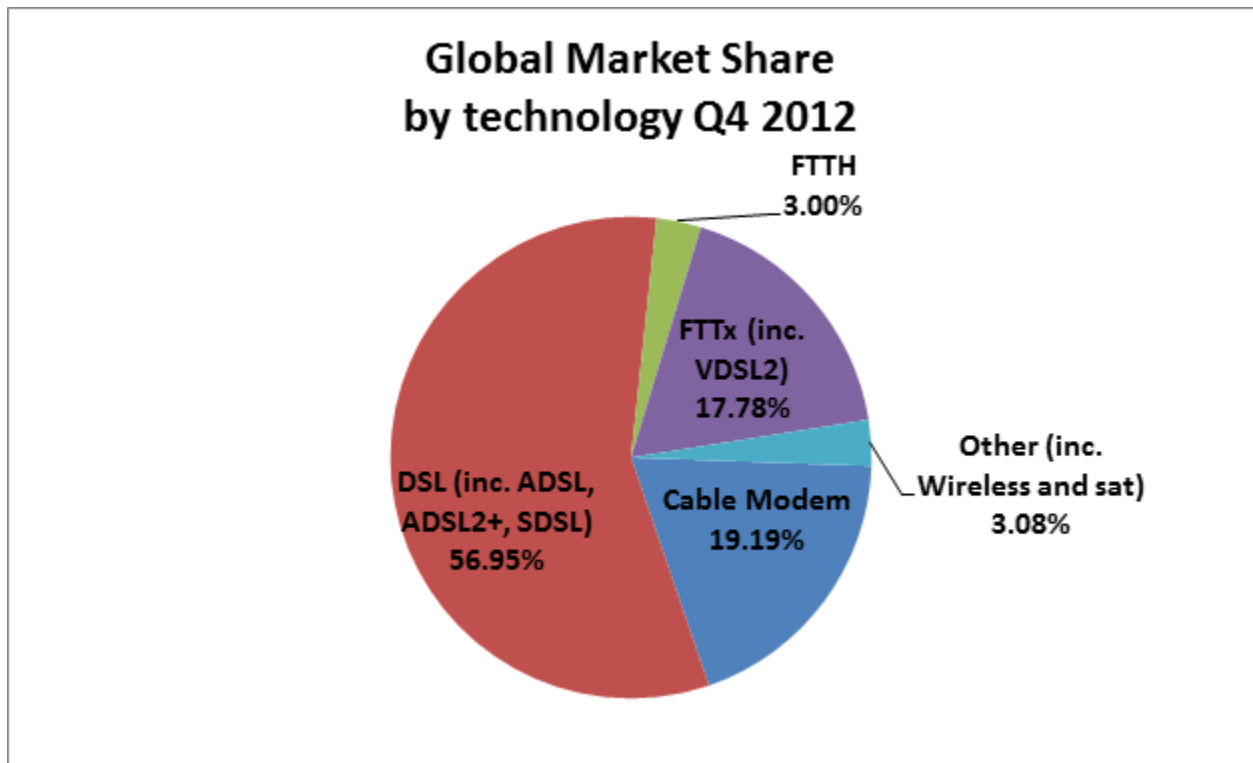

Figure 1 - Broadband access-connections for Q4 2012 (source: Point Topic). FTTx includes VDSL2, FTTx+LAN, etc.

DSL access over copper twisted pair provides many advantages for the Network Operator. These include operational ease of deployment, reuse of existing copper infrastructure thereby reducing the resource requirements to deploy new fiber, and ease of termination at the customer's premises. Data throughput over DSL is dedicated rather than shared to the customer and DSL's use of fiber to connect remote DSLAMs reduces fiber-deployment by sharing each fiber connection between 10's to 100's of customers connected to a remote DSLAM. In many cases, especially 'brown-field' situations, the resource requirements for deploying fiber all the way to the customer's premises can exceed the benefits of the enhanced services to the Network Operator and thus the deployment of fiber does not occur. In such situations DSL over copper for the final segment of the broadband connection may be the only viable broadband solution.

The ITU-T G.993.5 Recommendation provides a solution to this problem. As G.993.5 compliant equipment is developed the potential for improved bandwidth over VDSL2 connections is large. However the Network Operator deploying G.993.5 needs to address a number of operational and architectural issues in order to realize the benefits of vectored DSL. Among these issues are (1) avoidance or management of uncanceled crosstalk, (2) selecting which lines will benefit most from vectoring, (3) ensuring that non-crosstalk related noise is ameliorated by DSL Quality Management (DQM) techniques, and (4) presence of legacy CPE.

MR-257 covers the following topics related to G.993.5 vectored DSL.

Section 1 provides an overview of the technology that supports vectoring and illustrates potential benefits of vectored VDSL2 with respect to line rate and loop reach.

Section 2 describes the status of vectored VDSL2 technology in the market.

Section 3 provides an overview of potential deployment architectures for vectored VDSL2.

Section 4 discusses the operational issues faced by the Network Operator and potential solutions.

Updates in Issue 2 elaborate or further develop the following aspects:

- An updated Section 4.2 regarding the effects of crosstalk that is not canceled by vectoring on the performance of vectored VDSL2, addressing both the cases that arise from physical loop unbundling (i.e., multiple Network Operators co-existing using the same infrastructure loop plant) and gradual introduction of vectoring by a single Network Operator. Coexistence in the same cable for cases of both multiple vectored groups and mixed vectored and non-vectored lines is addressed.
- A new Section 4.2.3 regarding the existing and potential techniques for mitigating or avoiding the impact of uncanceled crosstalk on vectored lines and their trade-offs.

1 What is Vectoring - A Technical Overview

VDSL2 is the leading DSL access technology targeting broadband deployments at high bit rates. Although the wide bandwidths supported by VDSL2 have limitations in reach, the majority of the customers may be served through the use of fiber fed cabinets enabling customers located within a serving radius to receive services such as IPTV with VDSL2. With the self-FEXT cancellation provided by vectoring under certain conditions, significant improvements in signal-to-noise ratio may be achieved such that higher bit rates may be offered for a given loop length.

Figure 2 illustrates the deployment of a VDSL2 based service from the network to end customer premises. A fiber optic link or other backhaul technology provides a high-speed data connection to the DSLAM, and the individual wire pairs in the access cable provide the direct connection to individual homes. The digital subscriber line access multiplexer (DSLAM) may be located in a Central Office (CO) or in a cabinet at a remote terminal location. If a fiber optic link provides the data connection to the DSLAM, and it is located in a cabinet, it is referred to as fiber-to-the-node (FTTN) or fiber-to-the-cabinet (FTTC); when located inside a building it is referred to as fiber-to-the-building (FTTB). In addition to VDSL2, other signals such as ADSL2, ADSL2plus, SHDSL, or plain old telephone service (POTS) may exist in the cable. These non-VDSL2 signals create alien crosstalk with respect to the vectored lines.

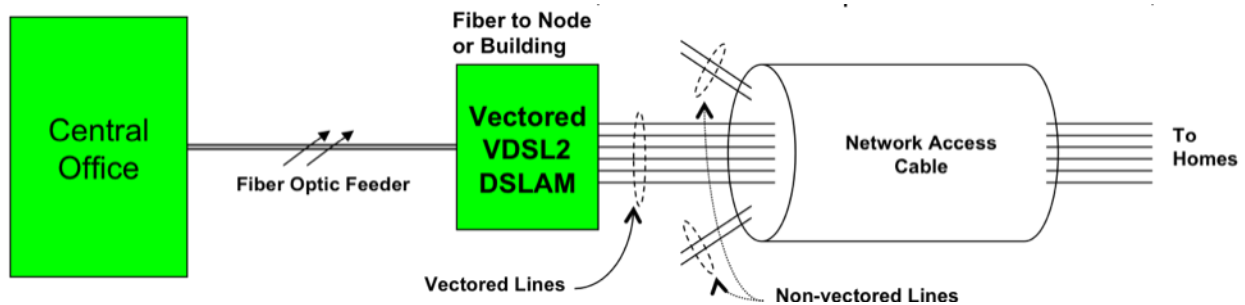

Figure 2 - Reference Fiber Fed DSL Network Access Architecture

The transmission performance of any DSL line depends on the loop length and the noise in the cable. Loop attenuation increases with increasing frequency and increasing loop length; as a result, the usable bandwidth decreases with increasing loop length. In addition to signal loss, the other major cause of bandwidth reduction for DSL is crosstalk among the signals in the same cable: namely near-end crosstalk (NEXT) and far-end crosstalk (FEXT); both NEXT and FEXT are shown in the cable diagram in Figure 3.

NEXT coupling is generally more severe than FEXT coupling. However, since VDSL2 uses separate frequency bands for upstream and downstream transmission, the upstream and downstream bands on all the wire-pairs in the cable never overlap so there is no self near-end crosstalk from similar signals in the cable. Hence, for VDSL2, the dominant crosstalk disturber is self far-end crosstalk (self-FEXT).

The levels of FEXT coupling between the wire-pairs will vary from pair to pair and with frequency. The matrix in Figure 3 represents a Channel Matrix that defines the individual pair to

pair couplings, on a per sub-carrier basis, of the far-end crosstalk in the cable and the diagonal component represents the direct channel response. Therefore, with respect to each particular line in the cable, this matrix represents the FEXT from other lines in the cable that interferes with the VDSL2 performance on that particular line.

If the cable is fed with only VDSL2 signals from the one DSLAM and the crosstalk couplings between the wire pairs in the cable were known at the VDSL2 frequencies, then the transmission of the VDSL2 signals from the DSLAM could be controlled and processed so as to cancel the self inflicted crosstalk. The result would be a significantly improved Signal-to-Noise Ratio (SNR) at each receiver and higher achievable bit rates. Therefore, the goal of vectoring is to learn and maintain the crosstalk channel matrix at appropriate frequencies in the VDSL2 bands and apply the signal processing necessary to cancel the crosstalk caused by the other VDSL2 signals into the desired VDSL2 signal for each end user.

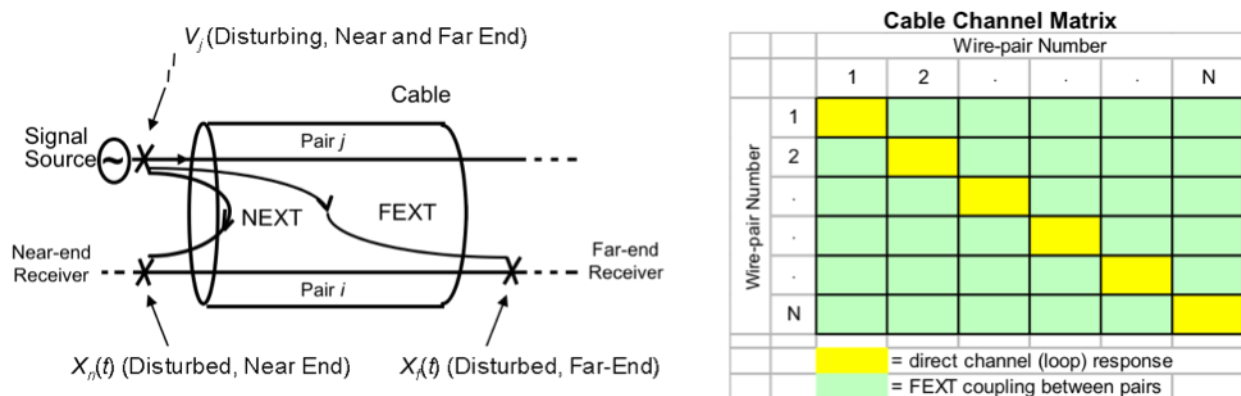

Figure 3 - Crosstalk in Access Cable

The “Vectored VDSL2 DSLAM” shown in Figure 2 is VDSL2-based supporting self-FEXT cancellation by vectoring. The “Vectored VDSL2 DSLAM” contains an array of collocated VDSL2 transceivers that are connected to a group of lines in the cable referred to as the *vectored group*. Assuming the channel coupling matrices for the vectored group are known, the synchronous transmit data samples are processed through the pre-coder matrix as shown in the block diagram in Figure 4. Based on the channel matrix of the vectored group, the pre-coder matrix implements the inverse of the crosstalk channel matrix such that when the data samples are received at the far-end receiver, the far-end crosstalk injected in the cable by the other transmitters is cancelled at the CPE receiver.

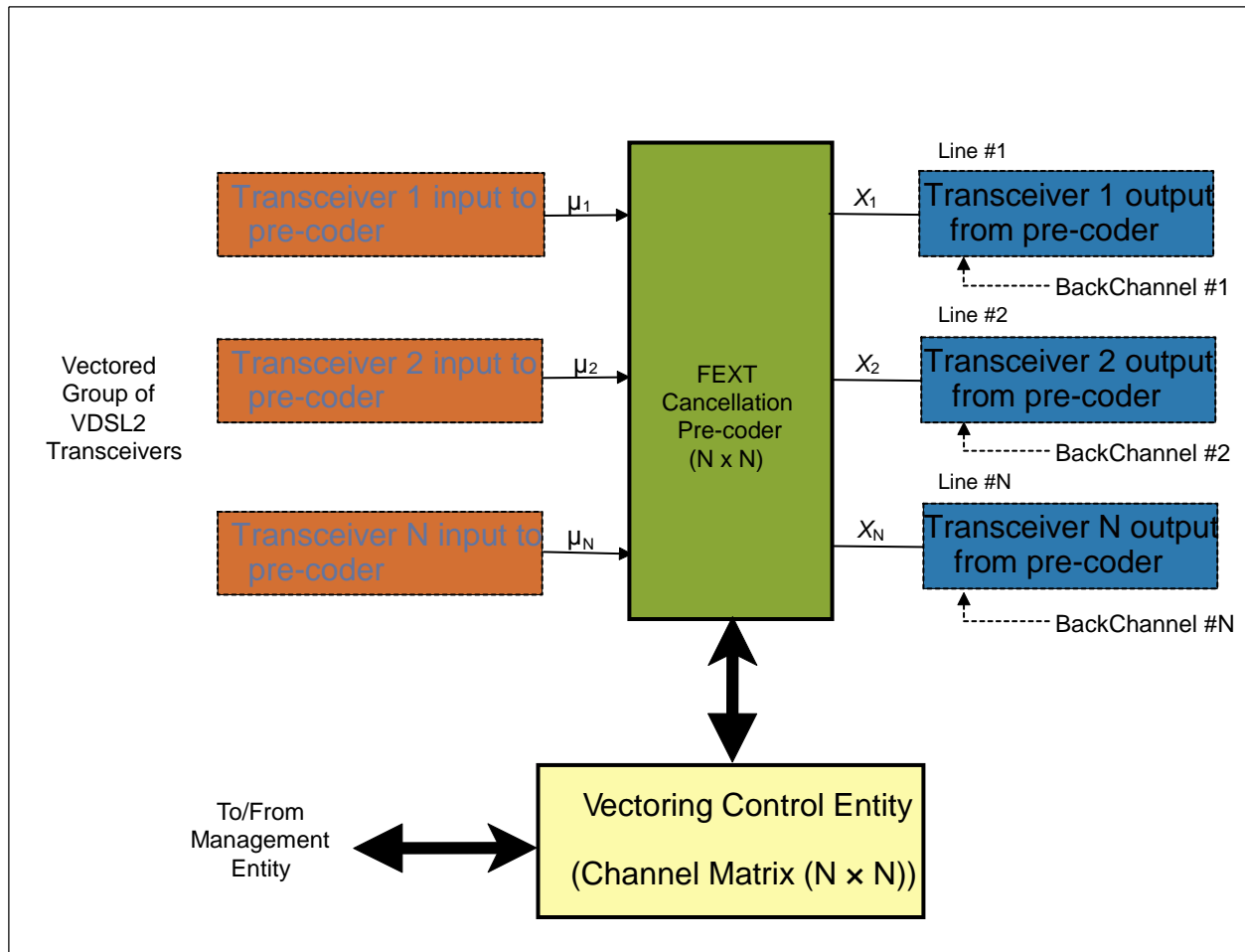

Figure 4 - Downstream FEXT Cancellation Pre-coding in DSLAM

To facilitate learning and tracking of the components in the Channel Matrix, error feedback information is communicated from the receiver to the Vectoring Control Entity (VCE) in the DSLAM. For downstream FEXT cancellation, error samples are reported from the receiver in the CPE to the Vectoring Control Entity in the DSLAM via a dedicated signaling channel on each line. The error samples contain the information collected by VDSL2 receivers regarding the FEXT from other VDSL2 lines. For upstream FEXT cancellation, all of the processing is done locally in the DSLAM.

With regard to vectoring it is important to note that the only cancelled crosstalk is that which is generated by the signals within the vectored group of subscriber lines. In Figure 2, the group of lines connected to the Vectored VDSL2 DSLAM is the vectored group. So far, we have assumed that all the lines in the vectored group terminate on vectoring capable CPEs. In this case, the “in-domain” self-FEXT created by all the lines in the vectored group is cancelled by vectoring. However, there are scenarios where there is crosstalk impairing the performance of the vectored group that is not cancelled by vectoring (see Figure 1/TR-320 [6]). For example, with reference to Figure 2, the additional lines labeled as “non-vectored” lines share the same cable with the vectored group and create “out-of-domain” self-FEXT (if they carry VDSL2 signals) or “alien crosstalk” (if they carry non-VDSL2 signals). In another example, some of the lines in the

vectored group may be terminated on legacy CPEs. The subset of lines in the vectored group terminating on vectoring capable CPEs forms the pre-coded group. Vectoring only cancels the self-FEXT from these lines. The subset of lines in the vectored group terminating on legacy CPEs creates in-domain self-FEXT that is not cancelled by vectoring.

In summary, the following kinds of crosstalk are relevant because they are not cancelled by vectoring:

1. In-domain self-FEXT generated within the vectored group but outside of the pre-coded group;
2. out-of-domain self-FEXT; and
3. alien crosstalk, i.e. crosstalk from non-VDSL2 sources.

There are several cases where the above types of uncanceled crosstalk are present.

- Cases where in-domain self-FEXT arises:
 - Gradual deployment, for example when the service on all the lines in a vectored group is not simultaneously upgraded and some lines may still be terminated on legacy CPEs.
 - Customer's service choices, for example some customers may not want to change service or their CPE, or technological choices driven by the Network Operator, or remote firmware update of CPEs to vectoring-friendly is not possible.
 - Regulatory or commercial regime, when the legacy CPE cannot be upgraded because it is not owned or managed by the same entity deploying the vectored DSLAM.
- Cases where out-of-domain self-FEXT arises:
 - Vectoring implementation, for example when board level vectoring (BLV) is used and multiple vectored groups (one per line card) are created.
 - Deployment, for example when lines in a cable are terminated on multiple DSLAMs. Note that whether the additional DSLAMs are vectored or not, they still create out-of-domain self-FEXT to the vectored group terminated on the first DSLAM unless cross DSLAM vectoring (xDLV) or cable level vectoring (CLV) are used.
 - Regulatory regime, for example when sub-loop unbundling (SLU) is allowed and multiple Network Operators own different DSLAMs (vectored or not) connected to the same cable.
- Cases where alien (non-VDSL2) crosstalk arises:
 - Presence of different services in the same cable, for example when the same cable carries ADSL or SHDSL in addition to VDSL2.

Issues for the Network Operators in the management of vectored VDSL2 lines and the impact of uncanceled crosstalk on the performance of vectored lines are addressed by the binder management in Section 4.1 and unbundled scenarios and gradual deployment in Section 4.2. Options for mitigating or avoiding the impact of uncanceled crosstalk on vectored lines are mentioned in Section 4.2.3.

1.1 Capabilities – Loop Reach and Rate

VDSL2 defines numerous profiles that correspond to the maximum available bandwidth of the transmit signal. The following two sections provide illustrations of the performance of G.993.5 based vectoring on the VDSL2 17 MHz profile Annex A 17a (G.993.2 [2]), and the Annex B 17 MHz profile 17a (G.993.2) and the Annex B 30 MHz 30a band profile (G.993.2).

1.1.1 Performance of G.993.5 for the VDSL2 Annex A 17a band profile

Figure 5 shows the frequency band-plan defined Annex A for Profile 17a that defines the frequency bands of upstream and downstream transmission up to 17MHz.

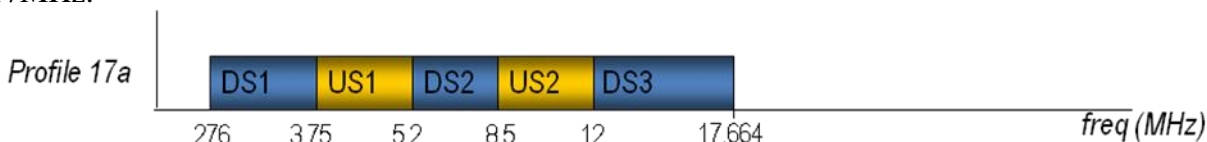

Figure 5 - Example band plans for profile 17a

Figure 6 shows an example of VDSL2 downstream performance with vectoring while operating with Annex A profile 17a on a 26 American Wire Gauge (AWG) cable² having 80³ VDSL2 users out of a possible 100 in the cable, with crosstalk from 47⁴ of those 80 users canceled by vectoring. In this illustrative scenario, the loop lengths for the users are randomly distributed from 50m to 1000m within the cable. The results show that, with vectoring, 100 Mb/s service is possible over 26 gauge loops of up to 500 m (approximately 1500 ft) and that 50 Mb/s service is possible up to approximately 900 m (approximately 2700 ft). The results in Figure 6 show that for a service rate of 50 Mb/s, vectoring provides an increase of 3 times the reach (approximately 600 m or 1800 ft) relative to the 99% worst-case crosstalk environment without vectoring. Therefore with the use of pair bonding and vectoring, 100 Mb/s service may be extended up to 900 m (approximately 2700 ft) when the Annex A profile 17a is used. It also allows the vectored lines to reach service rates close to the ones reached in the FEXT-free environment (i.e. as if there was only a single VDSL2 line operating in the whole cable, not disturbed by crosstalk from any other line).

² It should be noted that in some regions 0.5mm gauge or 24 AWG is more common in the distribution network and as such the length estimates for a given service speed should be multiplied by a factor of approximately 4/3.

³ This 80% fill is considered a very high take rate for VDSL2.

⁴ A cancellation level of 47 disturbers is chosen purely for illustration purposes – cancellation engines are now more advanced and can cancel the crosstalk from all VDSL2 users in the 100-pair cable.

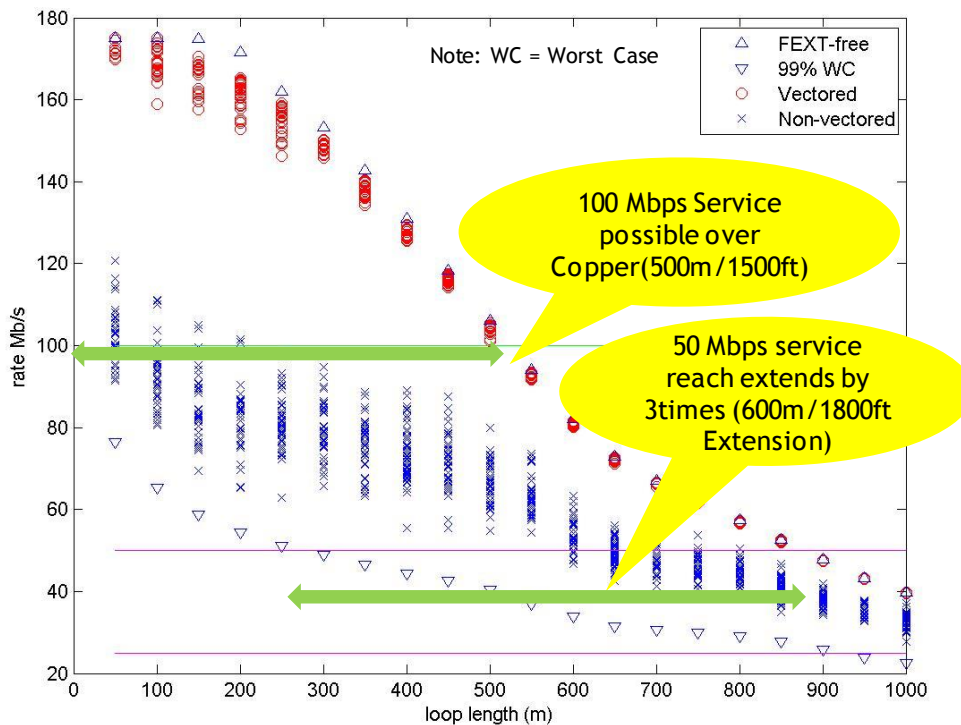

Figure 6 - Downstream Rates – Profile 17a, 26 AWG, -136 dBm/Hz noise, 80 users, and 47 cancelled

1.1.2 Performance of G.993.5 for the VDSL2 Annex B 17a and 30a band profile

Two additional examples of VDSL2 performance are provided based on VDSL2 Annex B as used in Europe. Figure 7 shows an example where the VDSL2 Annex B 17 MHz profile 17a is used with vectoring on 0.4 mm⁵ cable. The simulation assumes two cases, one where the VDSL2 is deployed on the same cable with analog voice and the other where the VDSL2 is deployed on the same cable deployed with ISDN. The curves identifying operation over analog voice are labeled ‘BA17a’ and those identifying operation over ISDN are labeled ‘BB17a’.

The top curves in Figure 7, labeled ‘FEXT-free’ represent the bit rates for when full crosstalk cancellation from vectoring is achieved. The lower curves show the bit rates without crosstalk cancellation for the scenarios of 15 and 49 self-disturbers⁶. As seen in Figure 7, 100 Mb/s downstream transmission with vectoring is feasible at 500 m of 0.4 mm cable and 50 Mb/s transmission is feasible at 900 m.

⁵ It should be noted that in some regions 0.5mm gauge or 24 AWG is more common in the distribution network and as such the length estimates for a given service speed should be multiplied by a factor of approximately 4/3.

⁶ That is there are 15 or 49 other VDSL2 lines operating in the same cable.

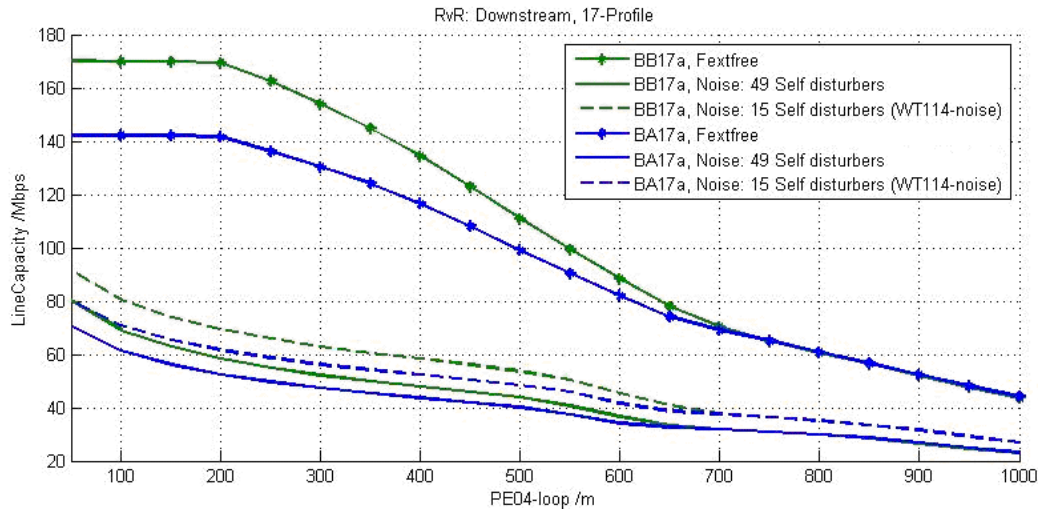

Figure 7 - VDSL2 Annex B Profile 17a downstream loop reach and rate

Similar to the above, Figure 8 shows the downstream performance with use of the VDSL2 30 MHz profile 30a when both operating on the same cable with analog voice and operating on the same cable with ISDN. The main difference is that significantly higher capacities are achievable at the shorter distances. Downstream rates over 200 Mb/s are achievable using this profile on loops up to 300 m in length.

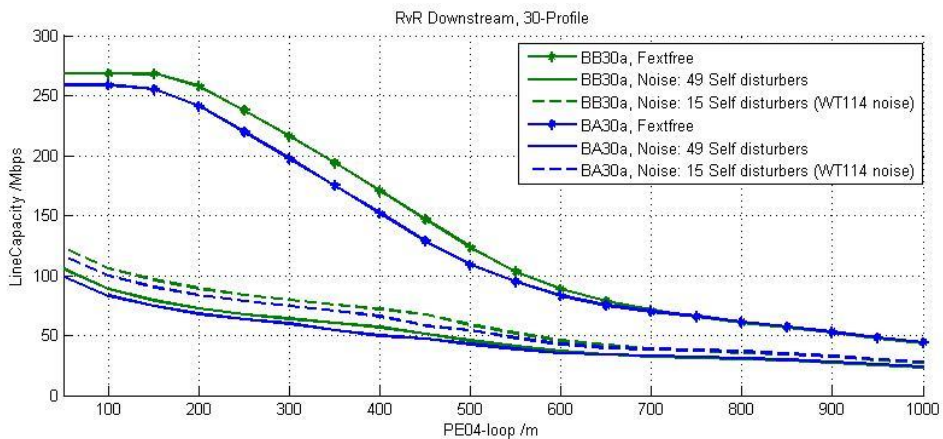

Figure 8 - VDSL2 Annex B Profile 30a downstream loop reach and rate

2 Status of the technology in the market

2.1 Standardization

The normative text in the ITU-T G.993.5 Recommendation specifies the downstream error signal and a method for transporting it, as required for interoperability of multi-vendor implementations. Additionally methods of deriving the Channel Matrix using the signal-to-noise ratio (SNR) per tone information available with the existing VDSL2 (G.993.2) parameters have been documented in an informative annex to G.993.5. Many implementation choices are not related to interoperability and are left to the discretion of the implementer.

The VTU-R (CPE modem) to VTU-O (DSLAM modem) backchannel carries the error samples gathered on the CPE which contain the information needed to build the Channel Matrix. The backchannel allows further refinement of the crosstalk channel estimation and tracking of crosstalk channel changes in Showtime. The VDSL2 initialization has been enhanced in G.993.5 to allow estimation of crosstalk channels, both in downstream and upstream directions. Initialization occurs such that a new line activating does not harm the lines already active so benefits from vectoring on the new line are achieved immediately. The VTU-O and VTU-R enter Showtime with the larger part of the crosstalk already cancelled.

The G.993.5 Recommendation also defines management parameters, which allow the Network Operator to configure the lines or frequency bands not to be vectored, or to obtain the downstream crosstalk channel characteristics.

3 Architecture

Table 1 lists network architecture requirements for the vectoring systems in typical deployment scenarios. Figure 9 illustrates these deployment scenarios.

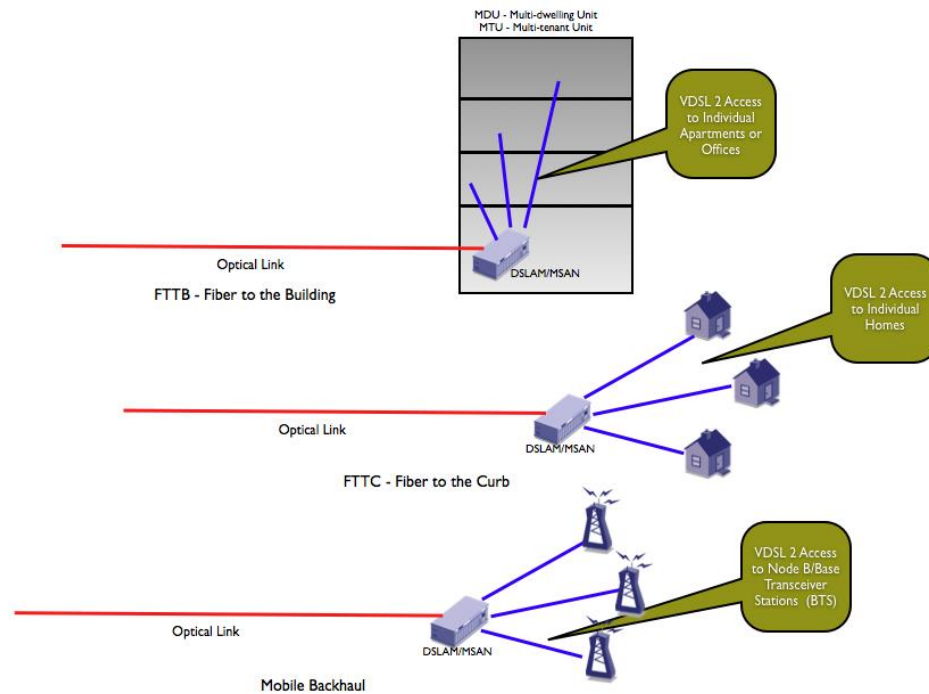

Figure 9 - Schematic of Deployment Architectures

Table 1 - Vectoring – Applications and Network Architecture

Network Architecture	FTTB	FTTC	Mobile Backhauling
Application	MDU/MTU	MSAN/DSLAM	BTS/Node B
VDSL2 profile	30a (17a)	17a (30a)	17a/30a
CO granularity (# of ports)	4-64	24-256	2-16
Loop length	< 300m	< 1km	< 1km

DSLAM products are available in two general architectures:

1. Board Level Vectoring
2. System Level Vectoring.

In the first architecture, known as Board Level Vectoring (BLV), the number of vectored lines is limited to the number of lines on a line-card (e.g., 64). Products using this approach are ideally

suited for FTTC, FTTB, or small FTTN deployments. In the second architecture, referred to as System Level Vectoring (SLV), vectoring is performed across multiple line-cards. This is suited for larger FTTN nodes.

4 Issues for the Network Operator and the Regulator

The following Table 2 summarizes the management issues raised for management of vectored DSL that are common to both vectored DSL and other network services:

Table 2 – Management Goals and Functions Common to Both Vectored DSL and Other Network Services

Topic	Potential issues
Management goals that are common to both vectored DSL and other networked services	<ul style="list-style-type: none"> • Minimizing technician dispatches to the field and customer's premises and the costs of cable conditioning and reconfiguration • Minimizing equipment complexity including the number of remote cabinets • Maximizing automated network operations, while minimizing changes to existing operations support systems • Maximizing service performance, network reliability and robustness
Management functions common to both vectored DSL and other network services	<ul style="list-style-type: none"> • Service management: service level agreement and quality of service • Inventory and assignment: what version of equipment is connected to which line • Configuration: "get" and "set" equipment configuration parameters • Performance monitoring: history log of operating performance and errors • Fault reporting: failure alarm and automated "snapshot" taken upon failure • Diagnostics: testing on demand

However vectored VDSL2 also raises specific Network Operator issues that especially affect deployment of vectored DSL. Table 3 summarizes those issues.

Table 3 – Management Concerns for Vectoring

Topic	Potential issues
Physical Plant Management	<ul style="list-style-type: none"> • Simplifying Binder group management and managing the size and members of the

	<ul style="list-style-type: none"> • vectored group • Service in areas with legacy VDSL - issues related to upgrades to DSLAMs, and legacy CPE • Wiring inside customer premises
Noise Management	<ul style="list-style-type: none"> • Impact of alien noise both stationary and impulse on vectoring • Addition and removal of VDSL2 on other lines, and power failure
Management and Diagnostics	<ul style="list-style-type: none"> • Measuring and monitoring performance • Diagnosing vectoring function • Diagnosing cable characteristics • Diagnosing noise characteristics
Vectoring Management	<ul style="list-style-type: none"> • Use of DSL Quality Management (DQM) techniques including DLM and DSM Level 1 and 2 (G.993.2 [2], TR-198 [7], ATIS DSM Report Issues 1 and 2 [8] [9], NICC DSM Report [10], TR-197 [11])

The following sub-sections provide additional detail on the issues raised in Table 3.

4.1 Binder Management Issues

To reduce inventory cost and power consumption, the Network Operator may equip vectored VDSL2 line cards as needed to meet service demand. As a result, a DSLAM may be initially equipped with only one line card, to which customers from any of the several distribution binder groups will be connected. As demand grows, more line cards will be added, one at a time. Again, customer lines from all binder groups will be connected to the newest line card as customers order service. As a result, each binder group may ultimately be served by several different line cards.

Furthermore, as some customers terminate service and others take service (“service churn”) the DSLAM line card ports may be reassigned to serve the new customers. These reassignments will be arbitrarily assigned to available ports without consideration of which binder group the line is in because existing network line assignment systems do not enforce mapping rules between line cards and binder groups.

If all the VDSL2 lines in the distribution cable are within the same vectored group, as would be the case for System Level Vectoring, vectoring gains are maximized. A DSLAM may support one or more vectored groups. If the forecasted number of vectored VDSL2 lines exceeds the number of ports on a DSLAM line card, then it is necessary for the vectored group to span multiple line cards. Depending on the projected service take-rate and distribution area size,

DSLAMs that support vectored groups of up to 400 ports may be needed. If some VDSL2 lines in any section of distribution cable do not belong to the same vectored group, then out-of-domain self-FEXT is present and this crosstalk will cause performance degradation in the vectored lines unless mitigation techniques are applied. Examples of mitigation techniques for reducing this degradation are given in Section 4.2.

In some cases it will be necessary to subdivide a distribution area to avoid lines being too long to provide the necessary service bit-rate. In this case, it should be feasible to place the multiple remote cabinets so that the cable sections served by each cabinet do not intersect with the cables served by the other cabinets. If two cabinets serve the same cable section, then out-of-domain self-FEXT is present and this crosstalk may cause performance degradation in the vectored lines unless mitigation techniques (e.g. DSM, xDLV) are applied, see TR-320.

4.2 Unbundled scenarios and gradual deployment of vectoring

This section describes several deployment conditions where it is not possible to ensure that all lines in a cable belong to a single vectored group. This coexistence of vectored lines with non-vectored lines or lines in a different vectored group leads to uncanceled crosstalk causing degradation to the performance of vectoring.

The impact of this uncanceled crosstalk on the performance gain achievable with vectoring is discussed in this Section. Remedies for mitigating or avoiding the impact of uncanceled crosstalk on vectored lines are discussed in Section 4.2.3.

4.2.1 Physical loop unbundling

The issue of current or anticipated future variability of crosstalk is particularly relevant for VDSL2 deployments in a regulatory regime where sub-loop unbundling is mandated (as is the case in many countries in the European Union). When physical loop unbundling is implemented, the incumbent Network Operator (who is normally the Infrastructure Provider) rents loops to competitive Network Operators allowing them to connect their own access equipment to the loop to offer broadband access to end-customers. To achieve the maximum benefits of crosstalk cancellation with vectoring, it is necessary to serve all the VDSL2 lines in the binder from the same vectored DSLAM. If two or more Network Operators are deploying VDSL2 links from different DSLAMs in the same binder, performance degradation in the vectored lines due to the presence of out-of-domain crosstalk can be expected. The lines in the vectored group deployed by one Network Operator will appear as out-of-domain disturbers to the other vectored group deployed by the other Network Operator. As a result, in the case of physical loop unbundling and if different Network Operators are deploying VDSL2 lines in the same binder, the gain that can be achieved by vectoring will be reduced.

Mitigation techniques can limit the reduction of vectoring gain due to uncanceled crosstalk. However, these techniques often require a performance trade-off among the peak speeds supported by each Network Operator. This trade-off generally requires that the data rates achievable by one group are reduced to increase the data rates achievable by the other group. In some cases, this trade-off can entail a significant reduction of the attainable peak speeds of one vectored group in order to maintain good vectoring gains in the other vectored group.

Furthermore, the effectiveness and complexity of mitigation techniques depends on the type of management coordination between Network Operators. A centralized management center with regular exchange of performance and resource utilization data among the networks allows for the best possible performances in a multi-operator environment, compared to the distributed management case where there are multiple management centers each with partial information about the network, see Section 6.1.3 of TR-320. However, it is still possible to achieve meaningful levels of uncanceled crosstalk mitigation if each Network Operator has its own separate management and independently follows “politeness” rules, e.g. by spectral shaping or by reducing transmit power (which in turn may lower the data rate) to create less crosstalk.

The effectiveness and acceptance of a mitigation technique will also depend on the definition of fairness for the competitive environment that physical loop unbundling seeks to enable.

4.2.2 Service in areas with legacy VDSL

In areas where VDSL-based services are already deployed, service providers and Network Operators may wish to use vectored VDSL2 to provide higher speed services without replacing the existing DSLAMs. It should be possible to introduce vectoring by upgrading the firmware and line cards in a legacy DSLAM. The new DSLAM should be able to support vectored VDSL2 lines in addition to continuing to provide the non-vectored VDSL2 service. When vectored VDSL2 is introduced in an existing VDSL2 service area, it may be highly desirable or required to keep legacy VDSL2 service offers. While some of the existing customers may choose to upgrade to the new, higher bit-rate service, other customers may wish to keep their current service and CPE. In these cases, some legacy lines may be upgraded, when possible, to vectoring with new CPEs, while the remaining legacy VDSL2 lines would employ mitigation to limit their impact on the upgraded vectored lines. This mitigation may also imply capping the rates of legacy VDSL2 services.

If all the VDSL2 lines in the distribution cable belong to the same vectored group, as in System Level Vectoring, then vectoring gains are maximized if all the lines in the vectored group terminate on vectoring capable CPEs. However, there are cases when legacy VDSL2 lines and new vectored VDSL2 lines share the same cable. For example, it may not be possible to put all legacy lines in a single vectored group, which may then cause the problem of in-domain or out-of-domain uncanceled self-FEXT from the legacy lines coupling into the new vectored lines (for more details about in-domain and out-of-domain self-FEXT, see the end of Section 1 and TR-320 [6]). This can happen in the case of multiple Network Operators (sub-loop unbundling, see also Section 4.2.1), or when a single Network Operator is carrying out a gradual deployment and upgrades only a subset of the DSLAMs in the cabinet to vectoring or when a Network Operator cannot replace all the legacy CPEs with vector capable ones.

4.2.3 Options for mitigating or avoiding the impact of uncanceled crosstalk on vectored lines

From a purely technical point of view, a single DSLAM with a single vectored group, full cancellation, and none of the lines terminated on legacy CPEs is the scenario that allows for the best vectoring performance because the level of uncanceled crosstalk is minimized. This scenario is also consistent with having a single vectored DSLAM that enables bit-stream access

to other service providers (e.g. VULA). However, as discussed in the previous two Sections and at the end of Section 1, there can be cases when uncanceled crosstalk is present regardless of whether there are multiple Network Operators or not. This uncanceled crosstalk can impair the performance of vectored lines if no action to mitigate its effects is undertaken.

There are techniques, technologies, network practices and other provisions that can mitigate the impact of uncanceled crosstalk on the lines in a vectored group.

The main options for mitigating the impact of uncanceled crosstalk on vectored lines are:

- Avoidance of multiple vectored groups in the same cable (e.g. avoidance of sub-loop unbundling with vectoring)
- Dynamic Spectrum Management, Level 1 and Level 2 [8] – [11]
- Cross-DSLAM Level Vectoring (xDLV)
- Cable Level Vectoring (CLV)
- Binder Management
- Vectoring friendly CPEs.

None of the above is able to remove or mitigate all uncanceled crosstalk in every case, but often a combination of these can achieve such a goal – see also TR-320 [6] for more details.

If a VDSL2 line is served from the same single vectored group, e.g. in the case of a single Network Operator, but is terminated on a legacy CPE, then the uncanceled in-domain crosstalk present can be eliminated by performing a firmware upgrade of legacy VDSL2 CPE modems so that they can operate in a “vectoring friendly” mode. In this mode, the legacy VDSL2 lines would continue to operate with the same performance as before, while helping the vectored lines maintain vectoring gains.

If vectoring-friendly and vectoring capable CPEs are present, and no legacy CPEs are used, then xDLV and Binder Management can avoid the impact of out-of-domain uncanceled crosstalk on vectored lines.

CLV has the potential to eliminate out-of-domain crosstalk but it is currently in the early stages of research and development and availability of mature products is still unclear.

Dynamic Spectrum Management (DSM) techniques [8], [9], [10], [11] can reduce the performance degradation suffered by the vectored lines due to non- vectored lines regardless of whether the uncanceled self-FEXT is in-domain (single Network Operator/DSLAM) or out-of-domain (multiple Network Operators/DSLAMs). DSM techniques could be applied (jointly or independently) to both legacy non-vectored and new vectored lines by shaping their respective PSDs and by introducing trade-offs between the peak speeds supported by each group of lines. In cases where excess capacity is available, i.e. lines that are rate limited or have excess margin, the reduction of data rate of non-vectored lines to preserve vectoring gains can be negligible. In the cases when excess capacity is not available, then it is necessary to cap the data rates of non-vectored lines to levels that are below their full capacity.

The deployment of any of these options encompasses network, operation and regulatory constraints and trade-offs which influence their effectiveness and benefits in preserving the performances of the vectoring system as well as the complexity vs. benefit considerations that drive Network Operators' deployment choices.

A detailed description of the above remedies (except for binder management) and their related network, operation and regulatory constraints and trade-offs to effectively deploy these solutions is reported in TR-320 [6].

4.3 Alien noise

With nearly all FEXT from disturbers in the vectored group being cancelled by vectoring, the remaining sources of interference (e.g. Radio Frequency Interference (RFI), impulse noise from electrical services in the home, interference from broadband power line communications, etc.) , referred to here as "alien noise," will become the dominant noise source. In some lines, alien noise that cannot be cancelled may be nearly as high as or higher than the self-FEXT that can be cancelled. Worse yet, vectoring could provide little gain or improved stability due to the anticipated future variability of alien noise. Service providers wish to assure a minimum service level is maintained in the presence of moderate-worst-case conditions. Thus, performance will be limited by an assumed statistical level of noise.

The potential loss of performance gain due to alien noise can be minimized and line stability can be maintained by:

- Tools that help determining the source of the alien noise. For example, if the alien noise is caused by broadcast AM radio, then it may be possible to eliminate the noise by grounding the cable sheath.
- DSL Quality Management (DQM) techniques including DLM and DSM Levels 1 and 2 (see Table 3 and [12], [7], [8], [9], [10], [11]) find the most effective line settings.
- Advanced techniques such as erasure decoding and ITU-T G.998.4 [13] physical layer retransmission to mitigate impulse noise, and use of data block interleaving with retransmission to mitigate RFI.
- Terminating the vectored VDSL2 at the exterior of the premises to avoid noise from wiring inside the premises, or use of a dedicated wire from a centralized splitter to the vectored VDSL2 CPE to avoid noise from the home POTS wiring.
- Receiver-based cancellation of alien noise. For example, a common-mode noise cancellation or other types of noise-cancellation functions at the customer-end receiver would be helpful since this type of noise is more often found at the customer end of the line.

4.4 Bonding and vectoring

The use of more than one VDSL2 line to provide service to a customer (bonding) enables much higher bit rates or service to longer lines. For residential services, bonding will usually consist of at most two lines, but up to twelve lines might be bonded to serve a business customer. For homes that do not have two pairs of inside telephone wire connected throughout the house, 2-line bonding would not be supported.

For the same line length, bonding two lines will approximately double the downstream and upstream service bit-rates. Alternatively, bonding may be used to increase line length. For the same bit-rate, bonding two lines enables approximately 50% longer lines than using one line.

Bonding in combination with vectoring could make 100 Mb/s service cost-effective for many additional customers. Bonding may be used selectively for only the longest or highest-bit-rate lines. Thus, the majority of customers, who are on short-to-medium length lines, would be served by a single line, and the added cost of two-line bonding would be necessary for only a small minority of lines.

4.5 Wiring inside the customer premises

Legacy VDSL2 deployments often convey the VDSL2 signal via inside wire to a VDSL2 modem located in a Residential Gateway (RG) inside the house. However, much of the alien noise on VDSL2 lines is coupled into the inside wire. In-home alien noise and also the additional VDSL2 signal attenuation due to the inside wire may be avoided by placing the vectored VDSL2 modem at the side of the house in a Network Interface Device (NID), so that DSL signals do not propagate over the in-home wire.

4.6 Addition and removal of VDSL2 signals on other lines

VDSL2 signals may appear and disappear at any time due to addition or removal of service, power failure, or a customer turning their modem on or off. Since it will take some time for the vectoring function to learn the new FEXT, the vectoring process must be designed to assure that errors do not occur in these situations.

4.7 Measuring and monitoring performance gain

In real-world conditions, we may find that vectoring sometimes does not achieve the expected performance gain in some cases. Vectored VDSL2 modems should provide built-in functions to measure the vectoring gain and maintain a performance log. If the vectoring performance gains fall below a threshold, an automatic “snapshot” should be taken of the line and noise conditions to aid later diagnosis.

4.8 Diagnosing the vectoring function

The vectoring function requires extensive diagnostic capabilities to help learn how it behaves and misbehaves under various conditions. The following information should be available:

- the version of vectoring function supported by the CPE modem on each line
- the type(s) of alien noise cancellation supported by the CPE modem
- whether a line is part of a bonded group
- estimated FEXT coupling characteristics between all vectored lines
- the measured alien noise as observed at both ends of a line
- the lines belonging to the vectored and pre-coded groups
- automatic “snapshot” of conditions upon a fault.

4.9 Diagnosing the cable characteristics

In addition to the usual attenuation per tone, the vectoring function should make use of the standard G.993.5 XLINps reports [3] that provide additional measurement of the cable crosstalk characteristics which could be helpful in detecting and locating cable faults. If possible, it is very

helpful to know the estimated distance to a fault. This is because once crosstalk is removed the remaining sources of interference will become the dominant noise source.

4.10 Diagnosing noise characteristics

There are several non-crosstalk (alien) and time-varying noises that plague DSL systems, especially in the home. Since vectoring cancels the crosstalk from disturbers in the pre-coded group, the vectored receiver is then exposed to alien noise much more than when crosstalk is present, so that alien noise may become the dominant noise source impairing vectored lines. Therefore, the effects of alien noise on vectored lines will be more noticeable than on the lines operating without vectoring. With vectoring, detailed frequency and time domain characterization of alien noise measurement is important.

4.11 Vectoring management

The following management capabilities are provided in the ITU-T G.997.1 Recommendation [14] to manage G.993.5:

- Disable or enable vectoring separately on each line
- Designate high or low priority for FEXT cancellation
- Set upper and lower bound frequencies for vectoring.

Vectoring also impacts other aspects of DSL management, as alien noise has a relatively larger effect on performance when vectoring is implemented and vectored and non-vectored lines may need to coexist. Vectoring can be performed without the use of other DQM techniques. However use of DQM techniques relating to line and spectrum management will generally provide significant performance benefits [12], [7], [6].

5 Conclusion

Vectored DSL as defined in ITU-T Recommendation G.993.5 supports service rates of greater than 100 Mb/s on loops up to 500 meters in length, enabling advanced application services to be carried over copper. With appropriate placement of DSLAMs, use of management tools and techniques such as bonding of vectored lines and use of DQM techniques, Vectored DSL becomes an important tool for a Network Operator to provide high bit-rate broadband services (including IPTV) to their customers.

Deployment of vectored DSL raises new operational issues for the Network Operator. If not mitigated, uncanceled crosstalk could decrease the vectored lines performances. Network Operators have several tools at their disposal for mitigating the impact of uncanceled crosstalk. Although none of these tools by itself can completely remove all types of uncanceled crosstalk, using a combination of SLV, xDLV, vectoring friendly CPEs, and DSM-based management can maintain vectoring gains in most deployments with or without physical SLU. In the future, solutions currently in research and development such as CLV could further improve the set of tools.

The management tools provided in both in the ITU-T Recommendation G.993.5 together with the work of Standards Development Organizations such as the Broadband Forum will ensure that vectoring emerges as a complete ecosystem which quickly enables its full potential. The emergence of vectored DSL enables the service provider to support the bandwidths required for higher valued premium services over their existing copper based networks.

6 References

The following references are of relevance to this Marketing Report. At the time of publication, the editions indicated were valid. All references are subject to revision; users of this Marketing Report are therefore encouraged to investigate the possibility of applying the most recent edition of the references listed below.

A list of currently valid Broadband Forum Technical Reports is published at www.broadband-forum.org.

Document	Title	Source	Year
[1] BBF Press Release 16 April 2013	<i>FTTx access now serves more than 105 million global subscribers worldwide, accessed at http://www.broadband-forum.org/news/download/pressreleases/2013/BBF_FT_Tx13.pdf</i>	BBF	2013
[2] G.993.2	<i>Very high speed digital subscriber line Transceivers 2 (VDSL2)</i>	ITU-T	2011
[3] G.993.5	<i>Self-FEXT cancellation (vectoring) for use with VDSL2 transceivers</i>	ITU-T	2010
[4] MR-180	<i>Achieving Quality IPTV over DSL</i>	BBF	2012
[5] MR-257	<i>An Overview of G.993.5 Vectoring</i>	BBF	2012
[6] TR-320	<i>Techniques to Mitigate Uncancelled Crosstalk on Vectored VDSL2 Lines</i>	BBF	2014
[7] TR-198	<i>DQS: DQM systems functional architecture and requirements</i>	BBF	2011
[8] ATIS Std. 0600007	<i>Dynamic Spectrum Management - Technical Report</i>	ATIS	2007
[9] ATIS Std. 0600007.2	<i>Dynamic Spectrum Management - Technical Report (Issue 2)</i>	ATIS	2012
[10] ND-1513	<i>Report on Dynamic Spectrum Management (DSM) Methods in the UK Access Network</i>	NICC	2010
[11] TR-197	<i>DQS: DSL Quality Management Techniques and Nomenclature</i>	BBF	2012
[12] TR-188	<i>DSL Quality Suite</i>	BBF	2010
[13] G.998.4	<i>Improved impulse noise protection for DSL transceivers</i>	ITU-T	2010
[14] G.997.1	<i>Physical layer management for digital subscriber line (DSL) transceivers</i>	ITU-T	2012

7 Definitions

The following terminology is used throughout this Marketing Report.

Alien Crosstalk	Crosstalk created by alien lines.
Alien Lines	<p>A set of lines is “alien” to a second set of lines within the same cable if its lines carry a DSL signal type that is different from the one carried by the lines in the second set.</p> <p>In the context of vectoring, alien lines are lines that carry any non-VDSL2 DSL signal and share the same cable with lines in a pre-coded group.</p>
Alien Noise	Any non-crosstalk noise impairing a DSL line, e.g. impulse noise, RFI, power line communication interference, etc.
Board Level Vectoring (BLV)	A vectoring architecture where a vectored group can span at most over the lines terminating on a single line-card. In BLV, there is one vectored group per line-card, and the lines terminating on different line-cards belong to different vectored groups.
Bonding	Use of multiple DSL lines combined at the DSL level to carry a single application payload to a customer. DSL bonding is defined in ITU-T Recommendations G.998.1, G.998.2, and G.998.3.
Cable Level Vectoring	In Cable Level Vectoring (CLV), the operation of vectoring is performed across all the pairs in a cable, regardless of whether they terminate on multiple DSLAMs or not.
Cross-DSLAM Vectoring	A vectoring architecture where the operation of vectoring is performed across multiple DSLAMs by coordinating them so that the vector group spans lines that terminate on different vectored DSLAMs.
Crosstalk	Interfering signal received in one copper pair of a cable from services in other copper pairs of the same cable
Dynamic Spectrum Management	An optimization framework incorporating parameters of the subscriber line environment and transmission systems that are time or situation dependent
Error Sample	The measurement made by a DSL receiver supporting vectoring that indicated the effect of crosstalk received into loop serving the DSL Line
Far-End Crosstalk	Crosstalk between DSL services at the far end of the copper loop away from the DSL transmitter
In-domain Self-FEXT	<p>This type of self-FEXT is generated by lines that belong to the same vectored group. There are three notable cases in vectoring:</p> <p>1) The in-domain self-FEXT generated by the lines in the Pre-Coded Group is cancelled by vectoring in both downstream and upstream.</p>

2) The in-domain self-FEXT generated within the vectored group but outside of the pre-coded group is cancelled by vectoring in both downstream and upstream if and only if those lines terminate on full vectoring-friendly CPEs.

3) The in-domain self-FEXT generated within the vectored group but outside of the pre-coded group is cancelled by vectoring in downstream only if and only if those lines terminate on downstream vectoring-friendly CPEs.

Infrastructure Provider	The owner or provider of the access plant or infrastructure who is normally also the incumbent Network Operator.
Legacy CPE	A CPE that is neither downstream vectoring-friendly (G.993.2 Annex N), nor full vectoring-friendly (G.993.2 Annex O), nor vectoring (G.993.5) capable.
Near-End Crosstalk	Crosstalk between DSL services at the near end of the copper loop near the DSL transmitter
Network Operator	The entity that operates the network which normally includes the physical plant and network elements, and is often also the Infrastructure Provider in the case of an incumbent Network Operator. However in the case of physical loop unbundling the Network Operator may be a different entity from the Infrastructure Provider.
Node-B	Hardware that is connected to the mobile phone network that communicates directly with mobile handsets. Base Transceiver Station (BTS) is used to refer to GSM base stations.
Out-of-domain Self-FEXT	This type of self-FEXT is generated by lines that do not belong to the vectored group. The out-of-domain self-FEXT cannot be cancelled by vectoring.
Pre-coder	The function for the downstream direction that performs the mathematical operation of self-crosstalk cancelation in a vectored group.
Pre-coded Group	The subset of lines in a vectored group on which vectoring is actually performed, i.e. lines that are terminated on both a vectoring-capable DSLAM and on vectoring capable CPEs. In the downstream (upstream), the vectoring is performed at the transmitter (receiver) side via pre-coding (post-compensation).
Self-Crosstalk	Crosstalk generated by neighboring VDSL2 lines.
Self-FEXT	FEXT created by lines carrying DSL signals of the same type. In vectoring context, FEXT generated by neighboring VDSL2 lines, either vectored or not. There are two types of self-FEXT: in-domain and out-of-domain.
Service Provider	This is the entity that provides the service to the end customer, and is normally the entity to which the end customer contracts for service.

There may be multiple Service Providers who contract for wholesale bit-stream or unbundled access to Infrastructure Providers' or Network Operators' access networks in order to provide their service.

Showtime	The state of a DSL connection when application payload data can be transmitted over the connection
System Level Vectoring (SLV)	A vectoring architecture where a vectored group can span over all the lines terminating on the vectoring capable DSLAM. In SLV, there is only one vectored group per DSLAM.
Vectored Group	The set of lines over which transmission from the Access Node is eligible to be coordinated by pre-compensation (downstream vectoring), or over which reception at the Access Node is eligible to be coordinated by post-compensation (upstream vectoring), or both. Depending on the configuration of the vectored group, downstream vectoring, upstream vectoring, both or none may be enabled (see ITU-T Recommendation G.993.5 clause 3 - definitions).
Vectoring	The coordinated transmission and/or coordinated reception of signals of multiple DSL transceivers using techniques to mitigate the adverse effects of crosstalk to improve performance (see ITU-T Recommendation G.993.5 clause 3 - definitions).
Vectoring Control Entity	The function in a vectored System that manages vectoring for the lines in a DSLAM
Vectoring Friendly	<p>Vectoring friendly operation is defined in the ITU-T G.993.2 Annex X (downstream friendly operation) and Annex Y (downstream and upstream or "full" friendly operation).</p> <p>Vectoring friendly operation as defined in Annex X allows cancellation of the downstream in-domain self-FEXT from lines equipped with downstream vectoring-friendly CPEs into the vectored lines of a pre-coded group.</p> <p>Full vectoring friendly operation as defined in Annex Y allows cancellation of the downstream and upstream in-domain self-FEXT from lines equipped with full vectoring-friendly CPEs into the vectored lines of a pre-coded group.</p>

8 Abbreviations

This Marketing Report uses the following abbreviations:

AWG	American Wire Gauge
BTS	Base Transceiver Station
CO	Central Office
CPE	Customer Premises Equipment
DQM	DSL Quality Management
DS	Downstream
DSL	Digital Subscriber Line
DSLAM	Digital Subscriber Line Access Multiplexor
DSM	Dynamic Spectrum Management
FEXT	Far End Crosstalk
FTTB	Fiber to the Basement
FTTC	Fiber to the Curb
FTTN	Fiber to the Node
IPTV	TV over Internet Protocol
MDU	Multi-dwelling Unit
MSAN	Multi-service Access Unit
MTU	Multi-tenant Unit
NEXT	Near End Crosstalk
POTS	Plain Ordinary Telephone Service
PSD	Power Spectral Density
RFI	Radio Frequency Interference
US	Upstream
VCE	Vectoring Control Entity
VDSL	Very High Speed Digital Subscriber Line
VDSL2	Very High Speed Digital Subscriber Line Issue 2 (ITU-T Recommendation G.993.2)
VTU-O	VDSL Transceiver Unit – Office – a VDSL2 transceiver in the network
VTU-R	VDSL Transceiver Unit – Remote – a VDSL2 transceiver in the customer’s premises

Notice

The Broadband Forum is a non-profit corporation organized to create guidelines for broadband network system development and deployment. This Broadband Forum Marketing Report has been approved by members of the Forum. This Broadband Forum Marketing Report is not binding on the Broadband Forum, any of its members, or any developer or service provider. This Broadband Forum Marketing Report is subject to change, but only with approval of members of the Forum. This Marketing Report is copyrighted by the Broadband Forum, and all rights are reserved. Portions of this Marketing Report may be copyrighted by Broadband Forum members.

The Forum draws attention to the fact that it is claimed that compliance with this Specification may involve the use of a patent ("IPR") concerning MR-257 Issue 2. The Forum takes no position concerning the evidence, validity or scope of this IPR.

The holder of this IPR has assured the Forum that it is willing to License all IPR it owns and any third party IPR it has the right to sublicense which might be infringed by any implementation of this Specification to the Forum and those Licensees (Members and non-Members alike) desiring to implement this Specification. Information may be obtained from:

Actelis Networks Inc.
47800 Westinghouse Drive, Fremont, CA 94539 USA

Adaptive Spectrum and Signal Alignment, Inc.
333 Twin Dolphin Drive, Redwood City, CA 94065 USA

Attention is also drawn to the possibility that some of the elements of this Specification may be the subject of IPR other than those identified above. The Forum shall not be responsible for identifying any or all such IPR.

THIS SPECIFICATION IS BEING OFFERED WITHOUT ANY WARRANTY WHATSOEVER, AND IN PARTICULAR, ANY WARRANTY OF NONINFRINGEMENT IS EXPRESSLY DISCLAIMED. ANY USE OF THIS SPECIFICATION SHALL BE MADE ENTIRELY AT THE IMPLEMENTER'S OWN RISK, AND NEITHER the Forum, NOR ANY OF ITS MEMBERS OR SUBMITTERS, SHALL HAVE ANY LIABILITY WHATSOEVER TO ANY IMPLEMENTER OR THIRD PARTY FOR ANY DAMAGES OF ANY NATURE WHATSOEVER, DIRECTLY OR INDIRECTLY, ARISING FROM THE USE OF THIS SPECIFICATION.

Broadband Forum Marketing Reports may be copied, downloaded, stored on a server or otherwise re-distributed in their entirety only, and may not be modified without the advance written permission of the Broadband Forum.

The text of this notice must be included in all copies of this Broadband Forum Marketing Report.

End of Broadband Forum Marketing Report MR-257